

SHIELDED SMD INDUCTOR DR358-1 SERIES

Features

- Low Profile Surface Mount Design
- Flat Top for Pick and Place
- Inductance Range from 1.0 μ H to 39.0 μ H
- Operating Temp. -20°C to +80°C
- Tinned Leads with Leaded Solder is Available (note 7)



ELECTRICAL SPECIFICATIONS AT 25°C

Part No.	Inductance (μ H) \pm 30%	DCR (Ω) Max.	I rated (A) Max.
DR358-1-102	1.0	0.045	1.72
DR358-1-222	2.2	0.075	1.32
DR358-1-272	2.7	0.105	1.28
DR358-1-332	3.3	0.110	1.04
DR358-1-392	3.9	0.155	0.88
DR358-1-472	4.7	0.162	0.84
DR358-1-562	5.6	0.170	0.80
DR358-1-682	6.8	0.200	0.76
DR358-1-822	8.2	0.245	0.68
DR358-1-103	10.0	0.200	0.61
DR358-1-123	12.0	0.210	0.56
DR358-1-153	15.0	0.240	0.50
DR358-1-183	18.0	0.338	0.48
DR358-1-223	22.0	0.397	0.41
DR358-1-273	27.0	0.441	0.35
DR358-1-333	33.0	0.694	0.32
DR358-1-393	39.0	0.709	0.30

MECHANICAL OUTLINES

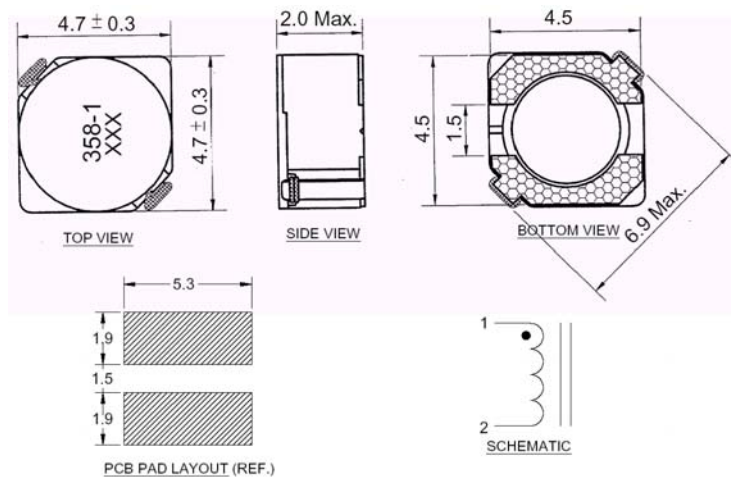

Notes:

1. All dimensions are shown in millimeter "mm"
2. General tolerance \pm 0.2mm, unless other specified
3. Inductance Test: 100kHz, 0.1Vrms
4. I_{rated} for an approximate 40°C temperature rise
5. I_{rated} for an approximate 35% drop maximum of the initial value
6. Tape and reel quantity, 2000 pcs/reel
7. For non-RoHS parts replace DR prefix with 42- (e.g. DR358-1 becomes 42-358-1)
8. Terminal finish is compliant to RoHS requirements. Solder in accordance with J-STD-020D